

ABSS138ESM-HF

**N-Channel
RoHS Device
Halogen Free**

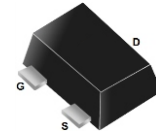

Features

- Low on-resistance.
- Low input capacitance.
- Fast switching speed.
- ESD protection up to 1.5kV (human body mode).
- AEC-Q101 Qualified.

Mechanical data

- Case: SOT-723, molded plastic.
- Molding compound: UL flammability classification rating 94V-0.
- Terminals: Matte tin-plated leads, solderability-per MIL-STD-202, method 208.

Circuit Diagram

- G : Gate
- S : Source
- D : Drain

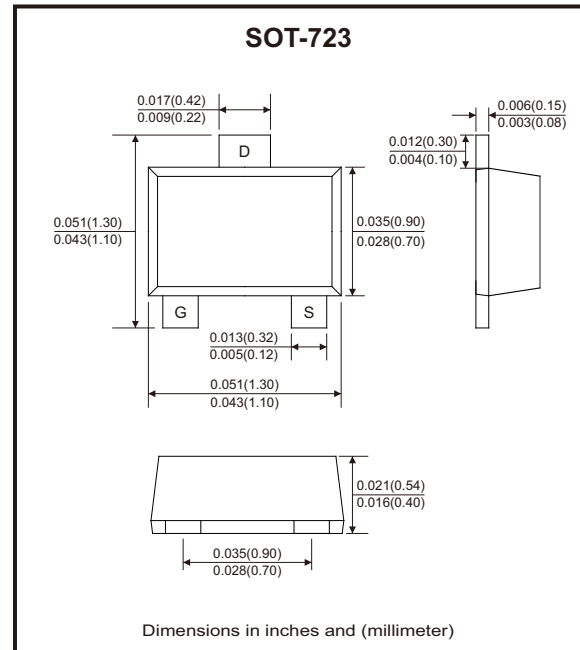
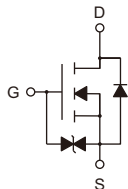

Maximum Ratings (at TA=25°C unless otherwise noted)

| Parameter | Symbol | Value | Unit |
|--|-----------------|-------------|------|
| Drain-source voltage | V_{DS} | 50 | V |
| Gate-source voltage | V_{GS} | ±20 | V |
| Continuous drain current (Note 1) | I_D | 360 | mA |
| Pulsed drain current | I_{DM} | 1200 | mA |
| Single pulse avalanche energy (Note 4) | E_{AS} | 0.2 | mJ |
| Power dissipation (Note 1) | P_D | 0.15 | W |
| Thermal resistance junction to air (Note 1) | $R_{\theta JA}$ | 834 | °C/W |
| Thermal resistance junction to lead (Note 1) | $R_{\theta JL}$ | 500 | |
| Thermal resistance junction to case (Note 1) | $R_{\theta JC}$ | 421 | |
| Operating junction temperature range | T_J | -55 to +150 | °C |
| Storage temperature range | T_{STG} | -55 to +150 | °C |

Electrical Characteristics (at $T_A=25^{\circ}\text{C}$ unless otherwise noted)

| Parameter | Symbol | Conditions | Min | Typ | Max | Unit |
|---|--------------|--|-----|------|----------|----------|
| Static Characteristics | | | | | | |
| Drain-source breakdown voltage | V_{DSS} | $V_{GS} = 0V, I_D = 250\mu A$ | 50 | | | V |
| Zero gate voltage drain current | I_{DSS} | $V_{DS} = 50V, V_{GS} = 0V$ | | | 1 | μA |
| Gate-body leakage current | I_{GSS} | $V_{GS} = \pm 20V, V_{DS} = 0V$ | | | ± 10 | μA |
| On Characteristics (Note 2) | | | | | | |
| Static drain-source on-resistance | $R_{DS(on)}$ | $V_{GS} = 10V, I_D = 0.5A$ | | 1 | 1.6 | Ω |
| | $R_{DS(on)}$ | $V_{GS} = 4.5V, I_D = 0.2A$ | | 1.2 | 2.5 | Ω |
| | $R_{DS(on)}$ | $V_{GS} = 2.5V, I_D = 0.1A$ | | 1.7 | 4.5 | Ω |
| Gate threshold voltage | $V_{GS(th)}$ | $V_{DS} = V_{GS}, I_D = 250\mu A$ | 0.8 | 1 | 1.5 | V |
| Dynamic Characteristics | | | | | | |
| Input capacitance | C_{iss} | $V_{GS} = 0V, V_{DS} = 25V, f = 1MHz$ | | 51 | | μF |
| Output capacitance | C_{oss} | | | 17 | | |
| Reverse transfer capacitance | C_{rss} | | | 9 | | |
| Total gate charge | Q_g | $V_{DS} = 25V, V_{GS} = 10V, I_D = 0.2A$ | | 4 | | nC |
| Gate to source charge | Q_{gs} | | | 0.5 | | |
| Gate to drain (miller) charge | Q_{gd} | | | 0.4 | | |
| Switching Characteristics (Note 3) | | | | | | |
| Turn-on delay time | $t_{d(on)}$ | $V_{DD} = 25V, I_D = 0.36A$ $V_{GS} = 10V, R_G = 6\Omega$ | | 2.2 | | ns |
| Turn-on rise time | t_r | | | 19.2 | | |
| Turn-off delay time | $t_{d(off)}$ | | | 6.2 | | |
| Turn-off fall time | t_f | | | 23 | | |
| Source-Drain Diode Characteristics | | | | | | |
| Diode forward voltage (Note 1) | V_{SD} | $I_S = 0.5A, V_{GS} = 0V$ | | 0.89 | 1.4 | V |
| Maximum continuous drain source diode forward current | I_S | | | | 0.36 | A |
| Reverse recovery time | t_{rr} | $I_F = 1A, dI_F/dt = 100A/\mu s$ | | 20 | | ns |
| Reverse recovery charge | Q_{rr} | | | | 10.7 | |

Notes: 1. Surface mounted on FR4 board, and standard footprint, $t \leq 10$ sec.

2. Pulse test: pulse width $\leq 300\mu s$, duty cycle $\leq 2\%$.

3. Guaranteed by design, not subject to production.

4. The EAS data shows Max. rating. The test condition is $V_{DS}=48V, V_{GS}=10V, L=0.5mH, R_G=25\Omega$.

Rating and Characteristic Curves (ABSS138ESM-HF)

Fig.1 - Output Characteristics

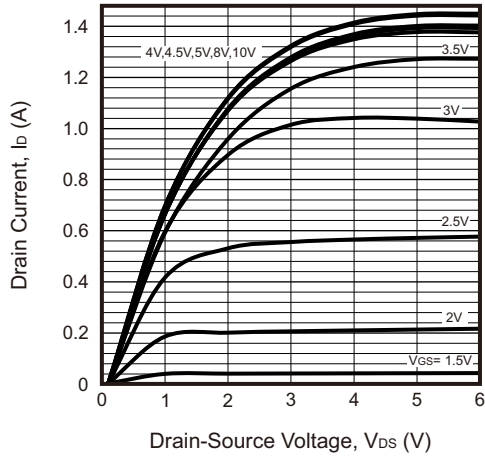

Fig.2 - On-Resistance vs. Drain Current and Gate Voltage

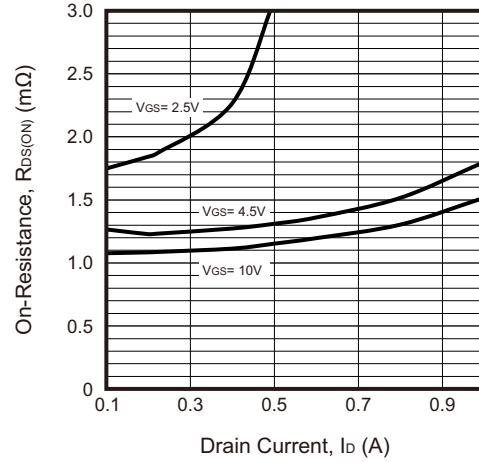

Fig.3 - On-Resistance vs. Gate-Source Voltage

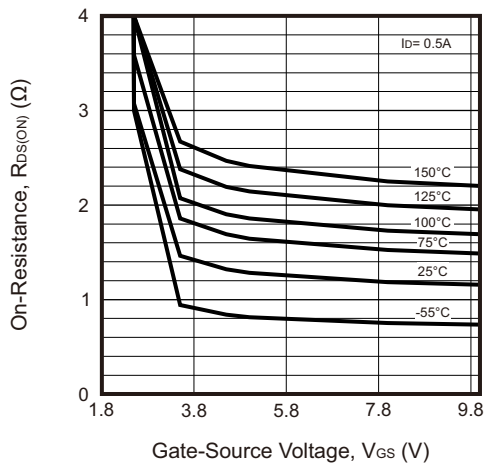

Fig.4 - Body-Diode Characteristics

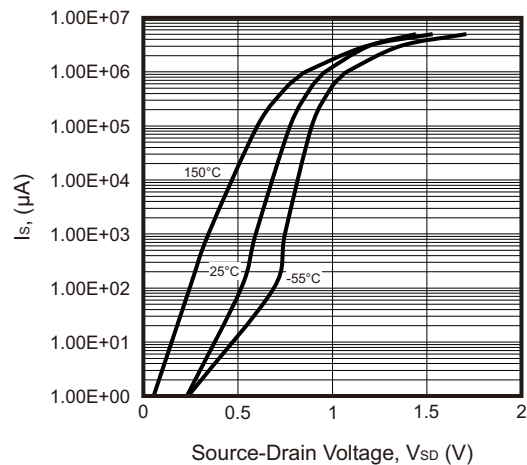

Fig.5 - On-Resistance vs. Junction Temperature

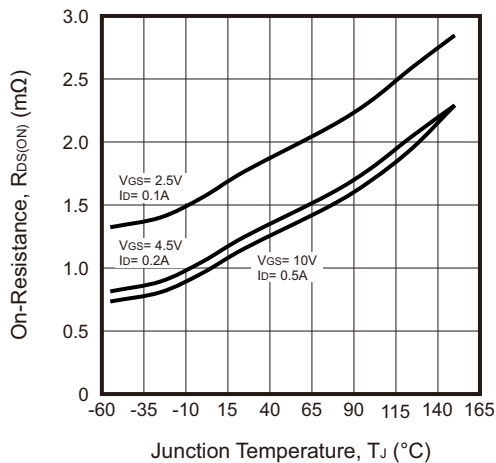
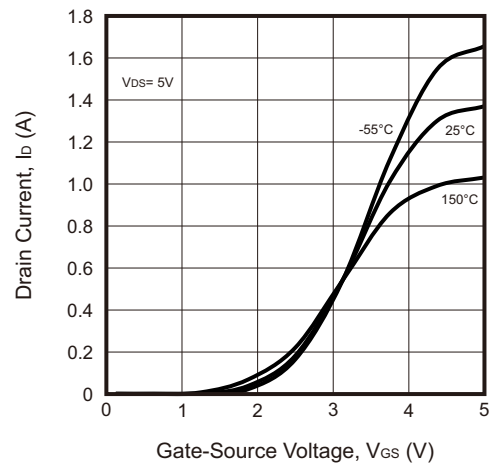

Fig.6 - Transfer Characteristics



Rating and Characteristic Curves (ABSS138ESM-HF)

Fig.7 - Gate Voltage vs. Junction Temperature

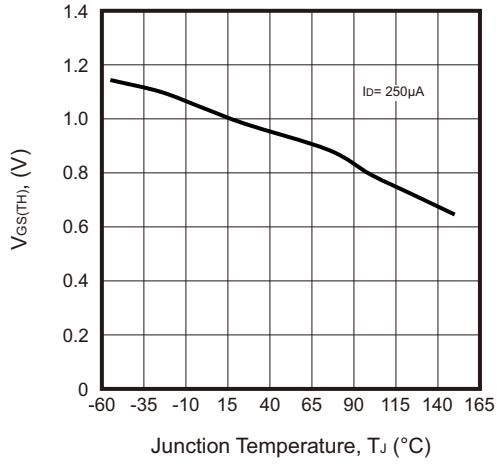

Fig.8 - Drain Source vs. Junction Temperature

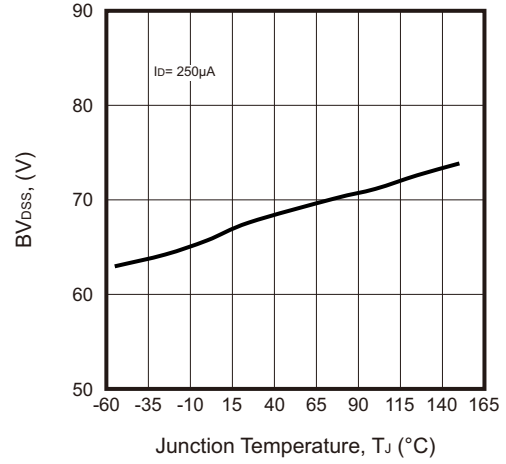

Fig.9 - Capacitance Characteristics

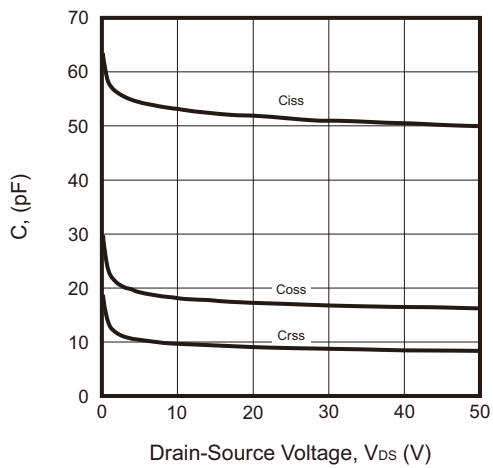
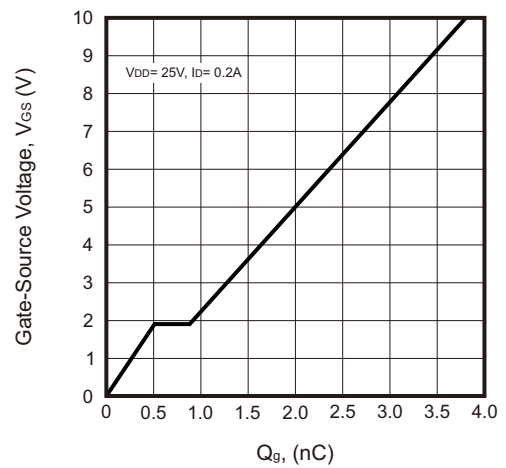
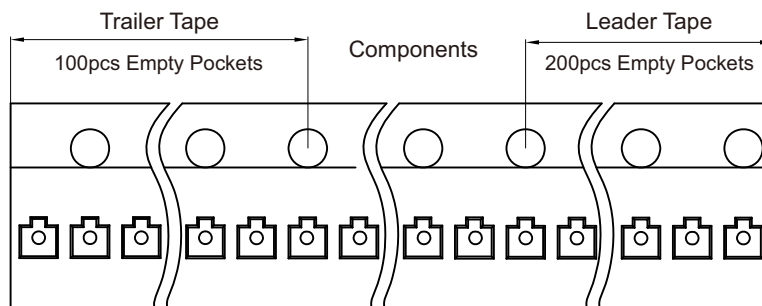
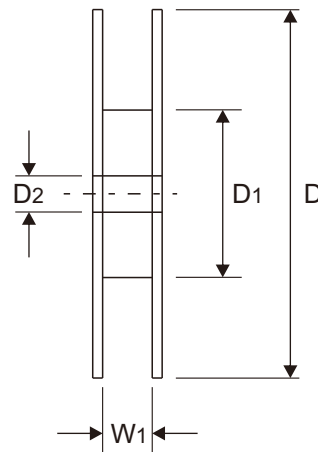
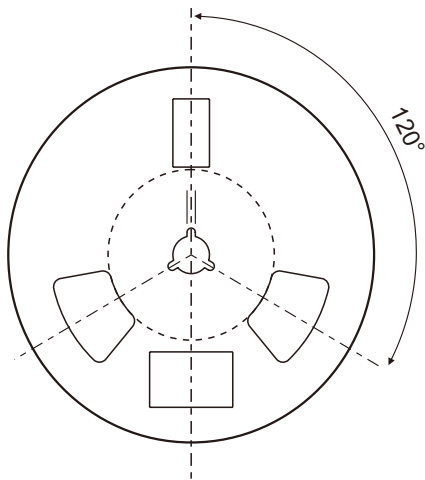
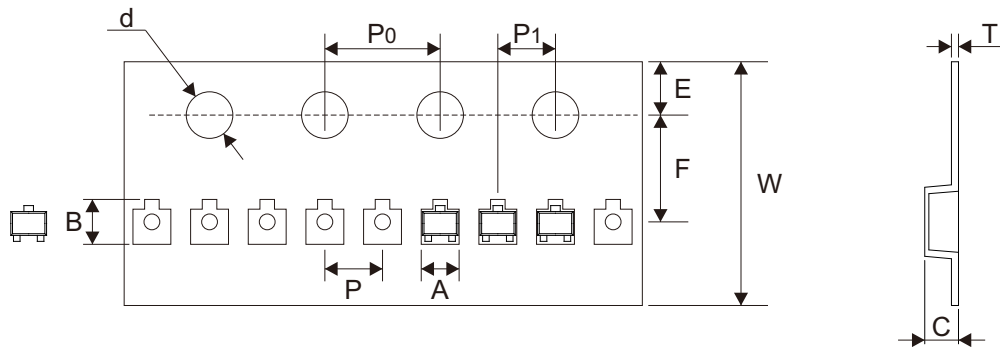

Fig.10 - Gate-Charge Characteristics



Reel Taping Specification



| SOT-723 | SYMBOL | A | B | C | d | D | D1 | D2 |
|---------|--------|---------------|---------------|---------------|---------------|---------------|---------------|---------------|
| | (mm) | 1.31 ± 0.05 | 1.45 ± 0.05 | 0.61 ± 0.05 | 1.50 ± 0.10 | 178.00 ± 1.00 | 54.00 ± 0.50 | 13.00 ± 0.50 |
| | (inch) | 0.052 ± 0.002 | 0.057 ± 0.002 | 0.024 ± 0.002 | 0.059 ± 0.004 | 7.008 ± 0.039 | 2.126 ± 0.020 | 0.512 ± 0.020 |

| SOT-723 | SYMBOL | E | F | P | P0 | P1 | T | W | W1 |
|---------|--------|---------------|---------------|---------------|---------------|---------------|---------------|--------------------------|---------------|
| | (mm) | 1.75 ± 0.10 | 3.50 ± 0.05 | 2.00 ± 0.05 | 4.00 ± 0.10 | 2.00 ± 0.05 | 0.20 ± 0.02 | 8.00 + 0.30 - 0.10 | 9.50 ± 1.00 |
| | (inch) | 0.069 ± 0.004 | 0.138 ± 0.002 | 0.079 ± 0.002 | 0.157 ± 0.004 | 0.079 ± 0.002 | 0.008 ± 0.001 | 0.315 + 0.012 - 0.004 | 0.374 ± 0.039 |

Marking Code

| Part Number | Marking Code |
|---------------|--------------|
| ABSS138ESM-HF | MM5 |

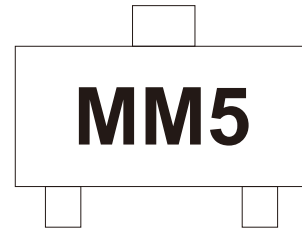

Suggested P.C.B. PAD Layout

| SIZE | SOT-723 | |
|------|---------|--------|
| | (mm) | (inch) |
| A | 0.45 | 0.018 |
| B | 0.50 | 0.020 |
| C | 0.40 | 0.016 |
| D | 1.15 | 0.045 |

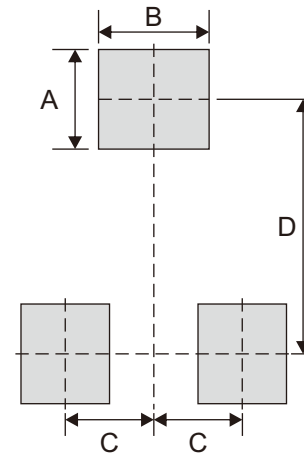

Standard Packaging

| Case Type | REEL PACK | |
|-----------|------------|------------------|
| | REEL (pcs) | Reel Size (inch) |
| SOT-723 | 10,000 | 7 |